

embedded accessories **Specification**

AS-NNR18VTD-XX-2 AS-NNR18VRD-XX-2



【Features】

- **Material:** aluminum;
- **Operating environment:** indoor;
- **Installation:** screw flat mounting;
- **Mounting hole size:** $\Phi 35\text{mm}$;
- **Warranty:** 6 years.

【Mechanical Parameter】

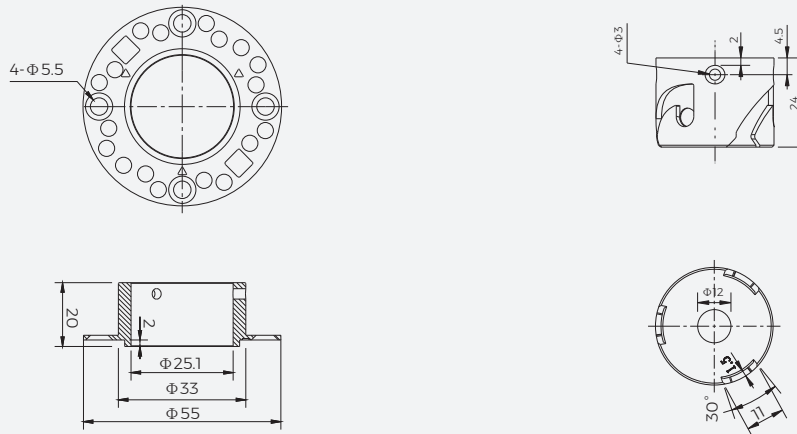

AS-NNR18VTD-XX-2

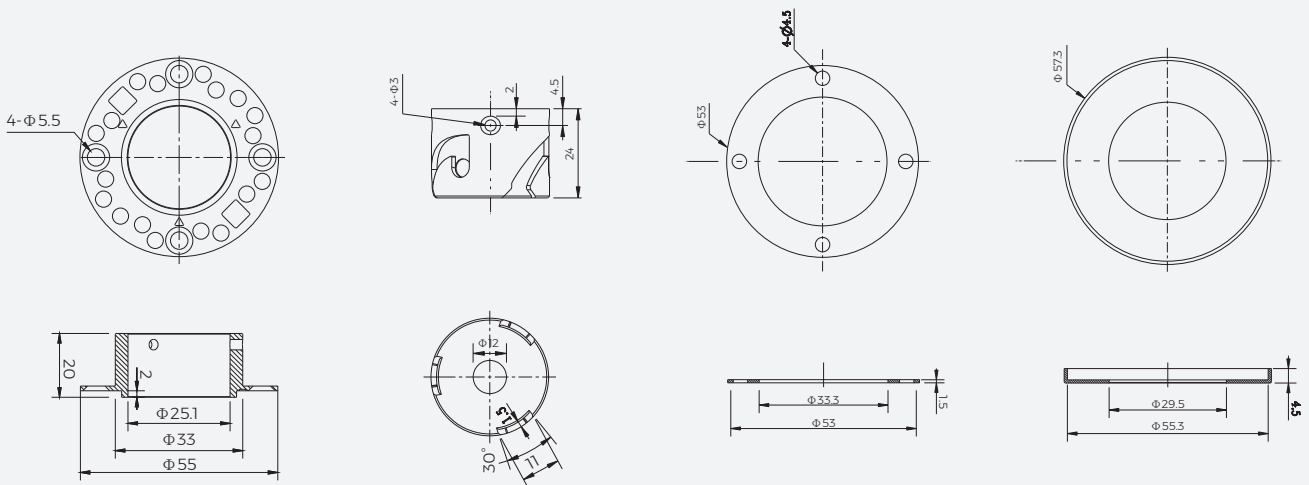

AS-NNR18VRD-XX-2



【Specification information】

Describe	Accessories Picture	Order model	Quantity/ case (PCS)	Net weight (kg)	Per box net weight (kg)	Gross weight (kg)	Packages (mm)	Range of applications
NNR18 Trimless embedded accessory		AS-NNR18VTD -XX-2	36	0.09	3.24	3.84	410*410*260	Appearance size: $\phi 55 \times 20$ mm Mounting hole size: $\phi 35$ mm
NNR18 Embedded accessory		AS-NNR18VRD -XX-2	36	0.14	5.04	5.54	410*410*260	Appearance size: $\phi 57 \times 20$ mm Mounting hole size: $\phi 35$ mm

【Precautions】

- Do not use any acid or alkaline adhesive to fix products(including not limited to glass cement,etc).
- After the installation of the lamps and lanterns is completed, do not pull violently, to avoid damage to the lamp.
- Maximum lifting weight of accessories is 4kg(No more than 5 meters).